

Thermal analysis and control for heating of an extrusion die

R. S. Vargas*, V. Gonda**, and L. C. Ruiz***

* Engineering and Applied Sciences Faculty, Universidad Técnica de Cotopaxi, 050101 Latacunga, Simón Rodríguez Av., Ecuador

**Department of Materials Technology – Bánki Faculty of Safety and Security Sciences, Óbuda University, 1081 Népszínház u. 8, Budapest, Hungary.

***Doctoral School on Safety and Security Sciences, Óbuda University, 1081 Népszínház u. 8, Budapest, Hungary.

ramiro.vargas@utc.edu.ec, gonda.viktor@bkg.uni-obuda.hu, lourdes.ruiz@bkg.uni-obuda.hu

Abstract — Heating and temperature control of tool blocks with high heat capacitance requires a proper setting of thermal control systems. The temperature distribution is highly non-uniform in the heating stage, and can deviate locally while reaching a stabilized state due to heat losses. In this study, a thermal analysis of heating an extrusion die is described. First a 3-D model of the extrusion die was constructed in SolidWorks. Subsequently, the model was imported to MARC Mentat finite element software and geometrically processed. Material properties and boundary conditions were assigned to the model considering heat conduction and heat convection. The heating power and heat transfer coefficient were taken as optimization parameters. In the parameter analysis, after several simulations, a comparison between values in real and in the modelled block showed agreement. With the theory about Proportional Integral Derivative (PID) controllers and using the values from simulation, PID parameters were computed.

Keywords: Thermal simulation, PID parameters, extrusion.

1 INTRODUCTION

In materials technology, hot working is a process where metal is plastically deformed at temperatures above the recrystallization temperature [1]. Rolling, extrusion, forging, drawing and rotary piercing are the most frequent hot working processes [2].

Extrusion is a process used to form materials. It consists of pressing a metal through a die with a specific shape [3]. Direct extrusion is carried out with a billet pushed through the die by a mobile stem; the material flow is on the same direction as the stem's motion. In indirect extrusion, the material flow is opposite to the stem movement. The billet is pushed by the stem and the material comes out from the opposite side. Fig. 1 shows a scheme of direct and indirect extrusion.

In high temperature processing, thermal control is fundamental for forming tool and the workpiece [4] [5]. Thermal controllers often use Proportional Integral Derivative (PID) type of control for the temperature setpoint [6]. A large block of an extrusion die is heated by the controllers that provide on-off type of heating power, and the actual temperatures in the different locations of the die may vary. For this reason, the data obtained to control the temperature along the channel is vital for the relevant thermal control. A real time thermal process takes a considerable time to show changes. Therefore, an

accurate simulation of the process, will show the process functioning and how the extrusion die may be affected [7].

The following study presents a thermal simulation of an extrusion die through finite element analysis. The heating process runs with a PID controller using pre-established parameters to reach the temperature setpoint. In order to run the simulation, a 3-D model of the extrusion die was obtained in SolidWorks software. This model was imported to MARC Mentat finite element software for further geometrical processing and setting up a thermal model. Material properties and boundary conditions taken from theory were assigned to the model [9]. Heating power and heat transfer coefficient were used as optimization parameters. After running several simulations, measured temperature data and values obtained in the simulation were compared and PID parameters were computed.

The purpose of the simulation was to obtain a comprehensive description of the temperature distribution and collect data for acquiring optimal PID parameters for future thermal control in real life heating processes.

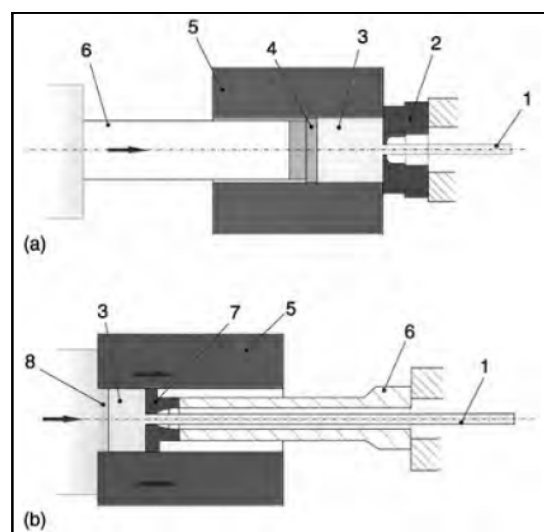

Fig. 1. Extrusion processes [8].

(a) Direct extrusion, (b) Indirect extrusion.

1, extrusion; 2, die; 3, billet; 4, dummy block; 5, container; 6, stem 7, dummy block with die; 8, sealing tool.

2 METODOLOGY

2.1 Three dimensional modeling and treatment

Before running the simulation, a three dimensional (3-D) model of the extrusion die was created in SolidWorks. This model was imported and geometrically processed in Marc Mentat studio [10]. The extrusion die consists of two parts symmetrically equal to each other, which are fastened with specific bolts. It lies over a metallic base with an established angle convenient for the stem to enter and press the billet.

The 3-D model design of the half of the extrusion die has been simplified with the purpose of a convenient geometry and mesh for the simulation software. Fig. 2 shows the simplified extrusion die after geometric operations. Since, the extrusion die in real life is made of stainless steel (hot working tool steel), these material properties were assigned to the design based on Table 1.

2.1.1 Point of interest

Before applying any force over the billet, the temperature in the corner of the extrusion die channel has to reach a specific value in order to obtain the desired metallic shape; this specific point in the extrusion die was designated as the point of interest. To achieve the required temperature, a thermometer was placed in the corner to control the temperature.

2.2 Initial Conditions Setting

Initial conditions were obtained using real life experimental data. Thus, the values established were:

- Initial temperature of the extrusion die: Assuming an average room temperature, the extrusion die temperature was set as 20°C.
- Power flux: The extrusion die face in contact with the power supply contains 91 nodes after the geometry and mesh treatments. Considering a power supply of 400 [W], a power per node of 4.4 [W] was set.

2.3 Boundary conditions

The modelled extrusion die consist of six faces:

- A face in contact with the power supply,
- A symmetric face,
- A face in contact with the metallic base,
- Three faces in contact with the air (room temperature).

Face flux boundary condition was assigned to the faces in contact with the ambient temperature and the face in contact with the metallic base, as shown in Fig. 3. A value of 5 [$\text{W}\cdot\text{m}^{-2}\cdot\text{K}^{-1}$] was assigned to losses due to the air and 100 [$\text{W}\cdot\text{m}^{-2}\cdot\text{K}^{-1}$] was assigned to losses due to the face in contact with the base. These two heat transfer coefficients (HTC) were taken from Table 2 as a starting reference.

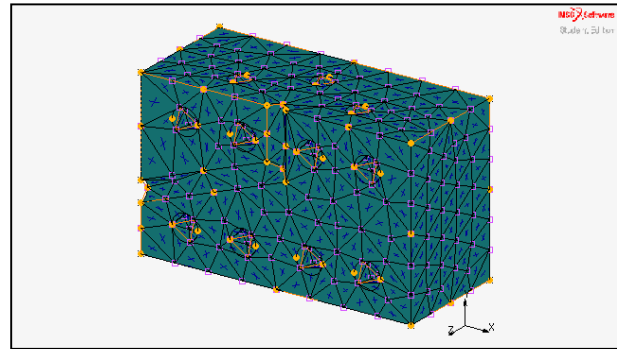
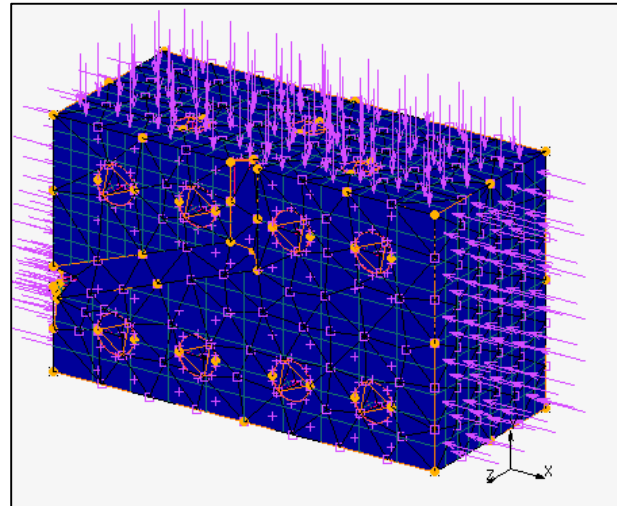
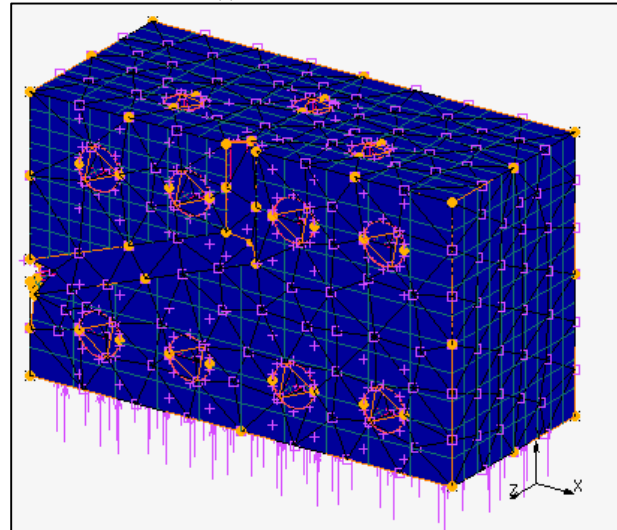

Fig. 2. Finite element mesh of the 3D modelled extrusion die.



(a) Losses due to the air



(b) Losses due to the metallic base.

Fig. 3. Heat losses due to the air and metallic base – Faces definition.

Table 1. Material Properties – International System (SI) [11]

Material	Thermal conductivity [$\text{W}\cdot\text{m}^{-1}\cdot\text{K}^{-1}$]	Density [$\text{kg}\cdot\text{m}^{-3}$]	Specific Heat [$\text{J}\cdot\text{kg}^{-1}\cdot\text{K}^{-1}$]
Aluminum 6061	180	2710	1256
Steel SAE 1010	63,9	7832	434
Steel, Stainless 316	16,26	8027,2	502,1

Table 2. Approximate values of heat transfer coefficient [12].

Conditions of heat transfer	[$\text{W}\cdot\text{m}^{-2}\cdot\text{K}^{-1}$]
Gases in free convection	5 – 37
Water in free convection	100 – 1200
Oil under free convection	50 – 350
Gas Flow in tubes and between tubes	10 – 350
Water flowing in tubes	500 – 1200
Oil flowing in tubes	300 – 1700
Molten metals flowing in tubes	2000 – 4500

2.4 Simulation

The aim of the simulation was to tune the values of the heat conduction parameter regarding the extrusion die faces in contact with air and the face in contact with the metallic base. The simulation was run using two scenarios from real experimentation to adjust the boundary values:

1. Constant Power Heating (CPH): the extrusion die was heated up with a constant power supply to analyze how the temperature rises on the die's point of interest.
2. Temporal Power Heating (TPH): the power supply was turned on for ten minutes and then switched off to measure the temperature/time changes when the extrusion die cooled down. This analysis was also done at the die's point of interest.

2.5 Results

One of Marc Mentat simulation software feature is to observe the results of a heating process with a color distribution according to the temperature. Furthermore, data from a certain node can be also seen and exported for further treatments. Simulated temperature is shown in Fig. 4 and Fig. 5, graphically describing the extrusion die simulation run in the second scenario. A contour band temperature distribution is shown Fig. 4, where the blue color represents the minimum temperature (47°C) and yellow represents the maximum temperature (55°C).

From Fig. 5, a time vs. temperature history plot in the point of interest was used to compare values from the simulation with real experiments values. This figure clearly shows that the values obtained by the simulation were as accurate as the values obtained in real life. This accuracy is shown in Fig. 6 and Fig. 7 where curves from the two scenarios are compared.

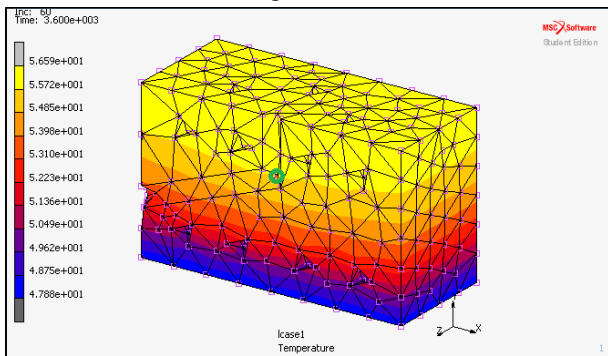

Fig. 4. Contour bands temperature distribution (minute 60). TPH scenario. Point of interest is marked by a green circle.

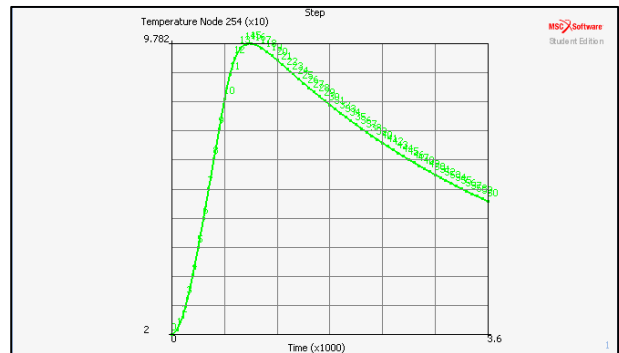

Fig. 5. Time vs. Temperature history plot –point of interest. TPH scenario.

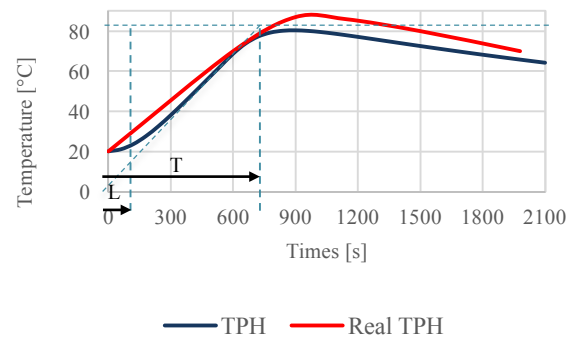

Fig. 6. Real vs. Simulated TPH process.

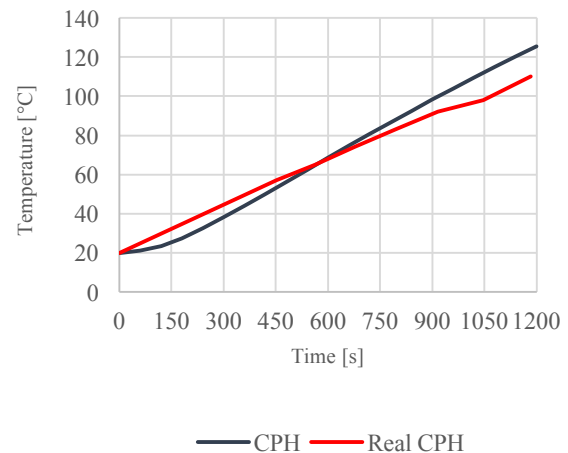

Fig. 7. Real vs. Simulated CPH process.

Table 3. Tuned values for boundary conditions - Die Simulation.

Power per – node	3.4 [W]
Film coefficient – air	20 [W·m ⁻² ·K ⁻¹]
Film coefficient – base	50 [W·m ⁻² ·K ⁻¹]

After running several simulations, a comparison between the obtained and real-life values was performed. As a result, tuned values for HTC regarding the extrusion die faces in contact with air and the metallic base can be proposed. These values are enumerated in Table 3.

In Fig. 6 and Fig. 7, the similitude between simulated and real life values are graphically described. However, in Fig. 6, auxiliary lines are needed for further Proportional Integrative Derivative (PID) analysis.

2.6 PID parameters

As the extrusion die has to reach a specific temperature, a controller is installed to the power supply in order to establish a set point (desired temperature). For this specific experiment, a PID controller was installed and tuned to proceed with the real life process. However, the tuning process could be improved by using parameters obtained from the simulation.

For computing PID parameters, the Ziegler Nichols method [13] was used. From the S-shaped response curve, T and L were obtained to calculate the gain, integral and derivative time given. Assuming $L \approx 100$ and $T \approx 725$ from Figure 6, Table 4 shows the computed values.

Table 4. PID parameters for the controller [14].

	Kp	Ti	Td
Original formula	1.2T/L	2L	0.5L
PID parameters	8.7	200	50

Finally, the resulting values for the PID controller can be tested to measure the time that the extrusion die takes to reach the setting point.

3 CONCLUSIONS

The present study described and analyzed the thermal modelling and the heating process control of an extrusion die using MARC Mentat finite element software for the simulation. A temperature distribution was obtained in a three-dimensional half of a die model. Due to the losses, the temperature distribution is not uniform in every part of it. The temperature is comparatively high at the top, whereas it is cold at the bottom. This fact is explained by the specific location of the heating element as well as the coefficients used for heat losses. Studying multiple tables from theory a value of $20 [W \cdot m^{-2} \cdot K^{-1}]$ and $50 [W \cdot m^{-2} \cdot K^{-1}]$ were assigned to the die faces in contact with the air and in contact with the metallic base, respectively. Moreover, a parameter study was performed for obtaining the heating power variation from 200 to 400 W.

Several iterations were run before stating the final values. Two different scenarios were identified as "Continuous" and "Temporal" power heating. Real values were also analyzed for the same cases. The values applied on one type of simulation fitted as accurate as possible with the second scenario.

Finally, real values and values obtained through the simulation were compared to obtain optimal PID parameters for the process. These suggested values are fundamental for a better and faster performance of the system.

4 REFERENCES

[1] R. Z. Valiev and T. G. Langdon, "Principles of equal-channel angular pressing as a processing tool for grain refinement," *Progress in materials science*, vol. 51, no. 7, pp. 881-981, 2006.

[2] E. P. DeGarmo, J. T. Black, R. A. Kohser and B. E.

Klamecki, *MATERIALS AND PROCESS IN MANUFACTURING*, Prentice Hall, 1997.

[3] A. D. Polyanin and V. E. Nazaikinskii, *Handbook of linear partial differential equations for engineers and scientists.*, CRC press, 2015.

[4] Y. A. Cengel and M. A. Boles, *Fundamentals of Thermodynamics*, New York: McGraw-Hill, 2002.

[5] A. F. Mills, *Basic heat and mass transfer*, Los Angeles: Irwin Inc, 1995.

[6] © OMEGA, "Temperature Process Controllers," OMEGA Global, [Online]. Available: <http://www.omega.com/prodinfo/temperaturecontrollers.html#learn>. [Accessed 29 April 2017].

[7] A. Bevacqua, A. E. Medvedev, A. Molotnikov, R. Axe and R. Lapovok, "Possibility to Predict Extrusion Die Incidental Fracture by Finite Element Simulation," *Advanced Engineering Materials*, vol. 19, no. 3, 2017.

[8] M. Bauser and K. Siegert, *Extrusion*, ASM International, 2006.

[9] T. Lestina and R. W. Serth, *Process heat transfer: principles, applications and rules of thumb*, Academic Press, 2010.

[10] Marc® MSC Software User Guide, *Demonstration Problems*, Munich, 2016.

[11] C. Kothandaraman and S. Subramanian, *Heat and Mass Transfer Data Book*, New Delhi: New Age International Ltd., 2014.

[12] © Thermopedia, "HEAT TRANSFER COEFFICIENT," Thermopedia TM, 2 February 2011. [Online]. Available: <http://www.thermopedia.com/content/841/>. [Accessed 2017 April 14].

[13] O. Katsuhiko, *Moderon Control Engineering*, New Jersey: Prentice Hall, 2010.

[14] D. Richard C. and B. Robert h., *Modern Control Systems*, Singapore: Pearson, 2008.