

COMPLEX STRUCTURAL ANALYSIS OF CORNERED SHAPE WATER CHAMBERS OF HEAVY-DUTY BOILER

István Bíró, József Solticzky, Ferenc Varnyú

Technical Institute, Faculty of Engineering,
University of Szeged, H-6724 Szeged, Mars sq. 7, Hungary
e-mail: biro-i@mk.u-szeged.hu, jsolticzky@t-online.hu, varnyuf@mk.u-szeged.hu

ABSTRACT

The Technical Institute of Faculty of Engineering of Szeged University received task to make a stress and construction analysis of a heavy-duty boilers fed by straw bales. Its documentation for manufacturing was purchased as a license from abroad. Main features of the construction and load of boilers are the followings:

- Its material: welding constructional steel;
- Large sized constructions;
- Cornered shape combustion and water chamber put into each other;
- The combustion and water chamber are covered by plate steel;
- Their stiffness are given by weld beams outside;
- Test pressure: 1 bar.

Solid Edge finite element method was used by authors to solve the problem. Regarding to the complexity of the construction the walls of the water chamber were analyzed separately. Results obtained by using the program were checked by different model investigations.

1. INTRODUCTION

The task is actually stress and construction controlling of a heavy-duty boilers fed by straw bales, taking into account the oversizing or undersizing of the combustion and water chamber. With other words: would it be possible to reach significant economy in material of the construction of the boiler. At the beginning of the analysis the construction seemed to be in some points under- in other points oversized. The sketch of the water chamber can be seen in Fig.1, the main dimensions of the back and side wall in Fig.2-3.

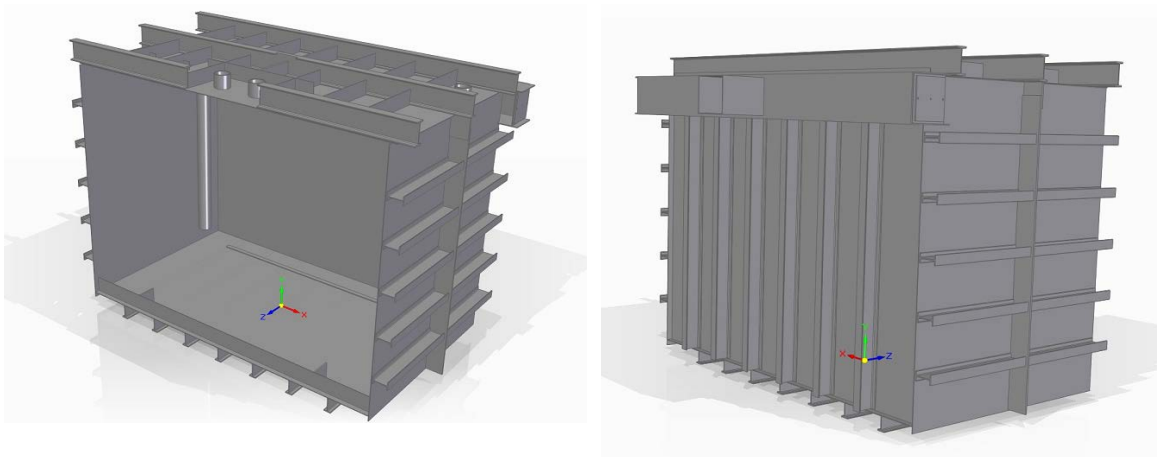

Fig. 1. Sketch of the water chamber in front and rear view

The stress analysis focused to the water chamber because the thickness of the wall of the combustion chamber was much more due to the heating load moreover its bracing was similar. We wanted to design a water chamber which corresponds to the load caused by test pressure 1 bar.

From this point of view the back and side walls of the water chamber are critical ones (Fig.2-3). The manufacturer realized some discontinuities along the vertical edges of the water chamber.

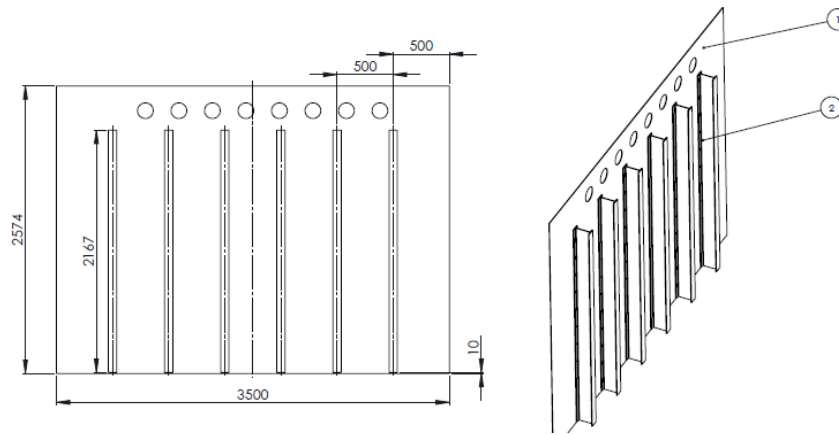

Fig. 2. Back part of the water chamber

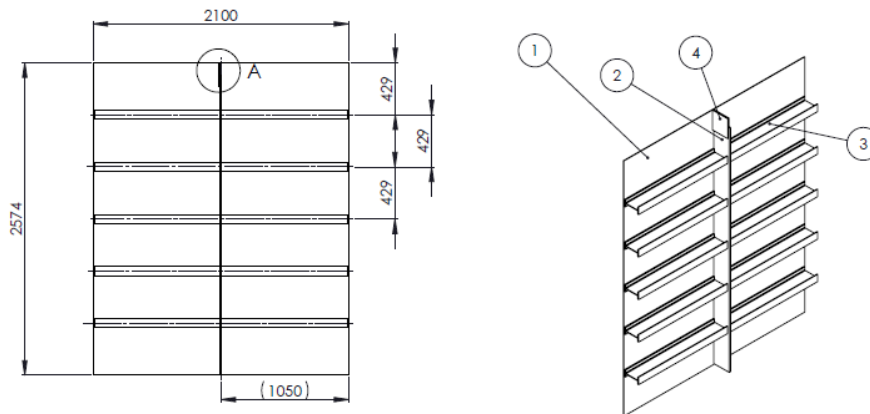

Fig. 3. Left side of the water chamber

For solving of the task Solid Edge finite element software were used. This program is applied for solution of similar problems. According to the designers of the software it is important to compare the results of the simulation with practical experiences and/or results of different tests.

2. THE APPLIED TESTMODEL

Since the shape of water chamber of the boiler is quite difficult, the application of traditional mechanical methods is limited. The program was tested by a simple mechanical model (Fig.4). The closed frame at its top and bottom is open. Main dimensions: 400x400x200 mm, wall thickness 5 mm. The walls of the frame are loaded inside by pressure of 1 bar. In Fig.4 the stress on the surface in different color and the enlarged deformation can be seen.

The ends of walls are blocked. Their moment curve in Fig.5 can be seen. The maximum values of stress can be observed at the ends of walls and at the edges of spatial model. It is in accordance with the shape of moment curve. In this case the results obtained by application of traditional mechanical methods and finite element analysis (stress and deformation) are scarcely the same ($\sigma_{\max}=312$ MPa).

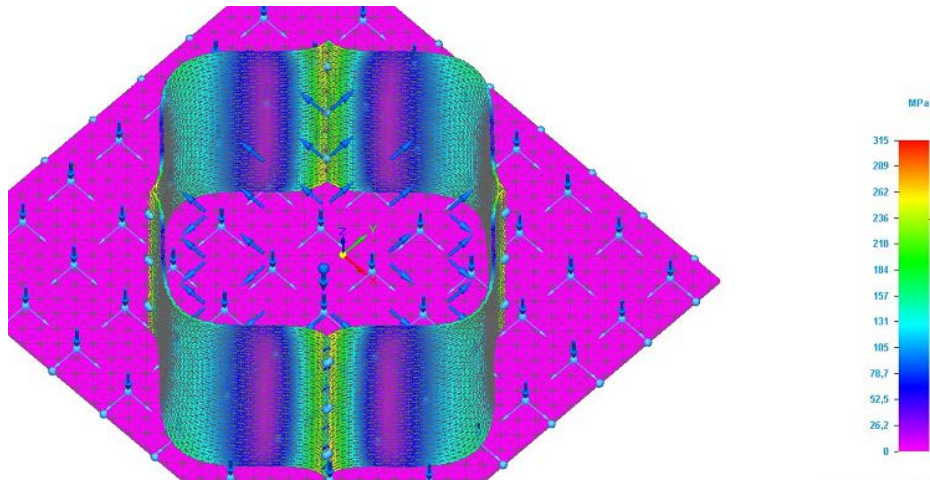

Fig. 4. Deformation and stress on the surface of the analyzed model

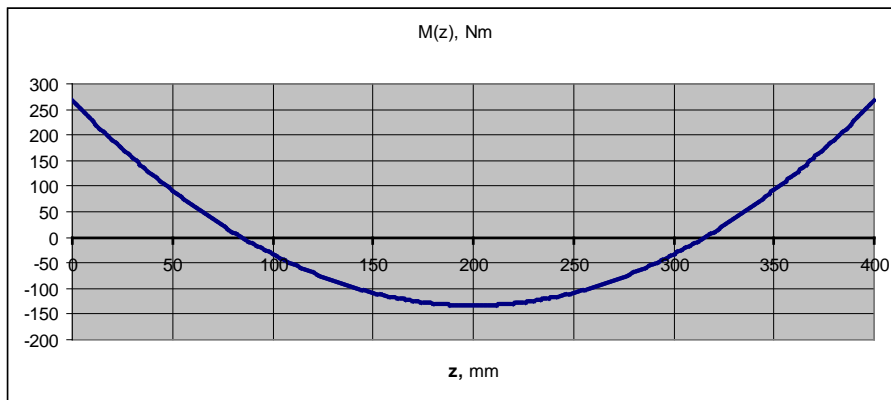

Fig. 5. Typical moment curve of the wall of the model

3. ANALYSIS OF MAIN ELEMENTS OF THE WATER CHAMBER

The controlling of main elements of the open water chamber (Fig.1) consists of the stress analysis of five plates. The critical parts of the construction are the back and side walls for this reason their results will be demonstrated (Fig. 6-10).

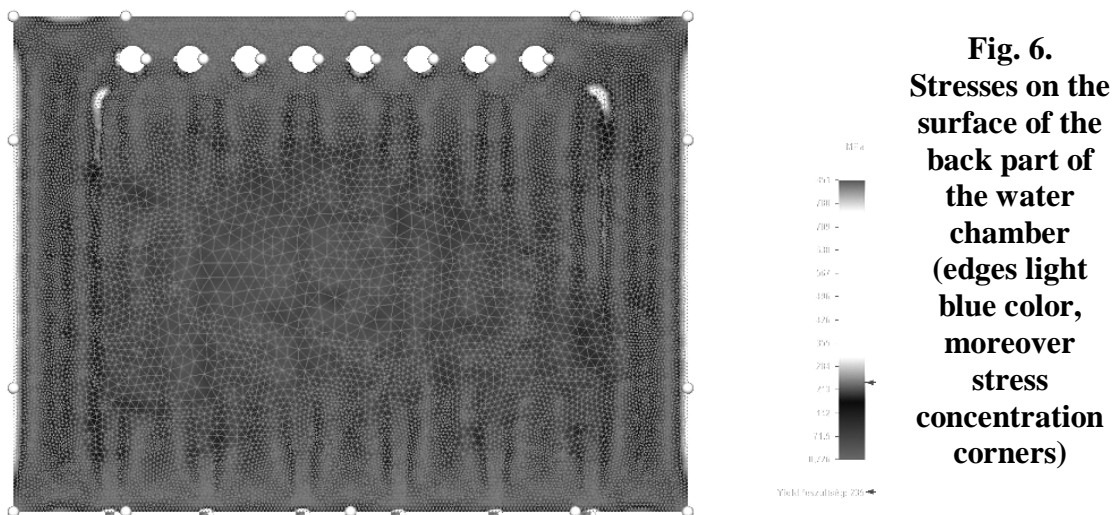

Fig. 6. Stresses on the surface of the back part of the water chamber (edges light blue color, moreover stress concentration corners)

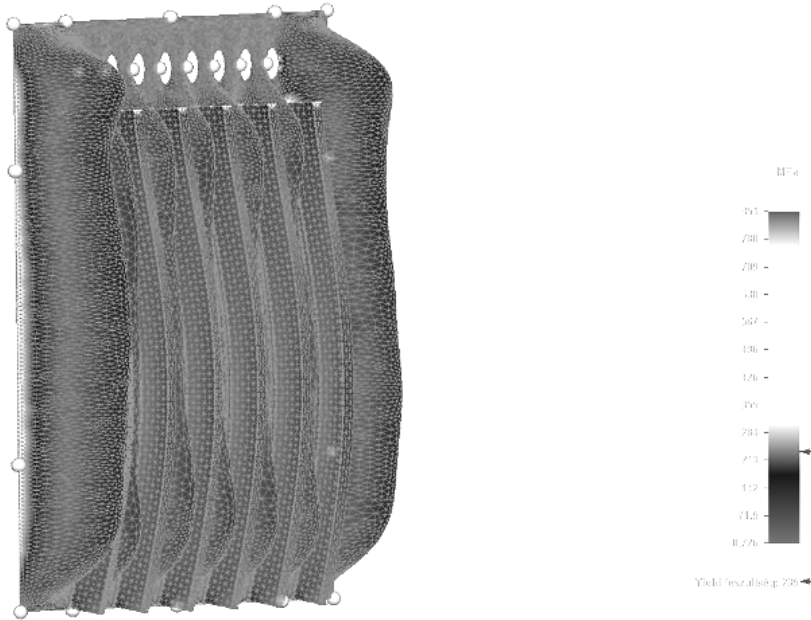

Fig. 7.
Stresses on the surface of the back part of the water chamber (rotated position)

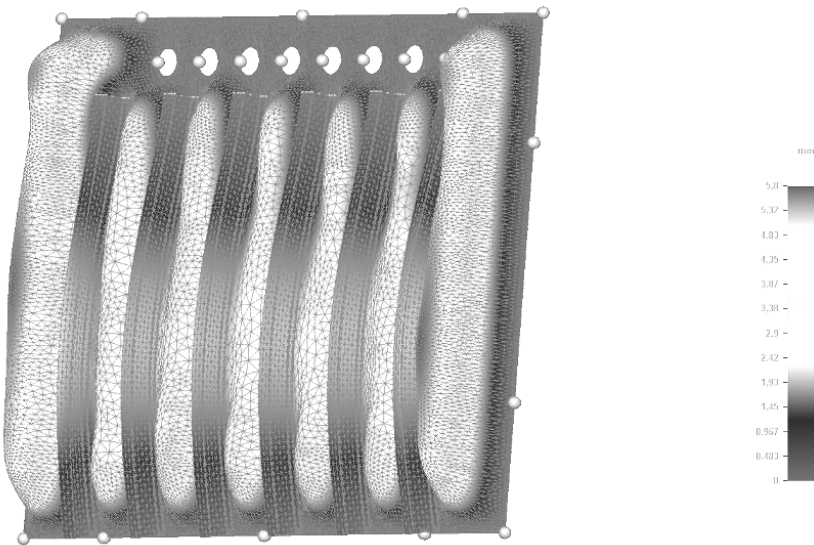

Fig. 8.
Deformation of the back part of the water chamber (enlarged demonstration)

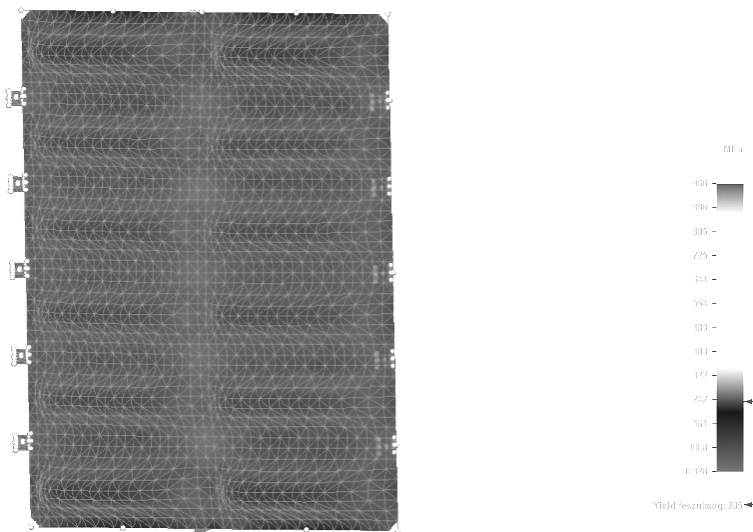
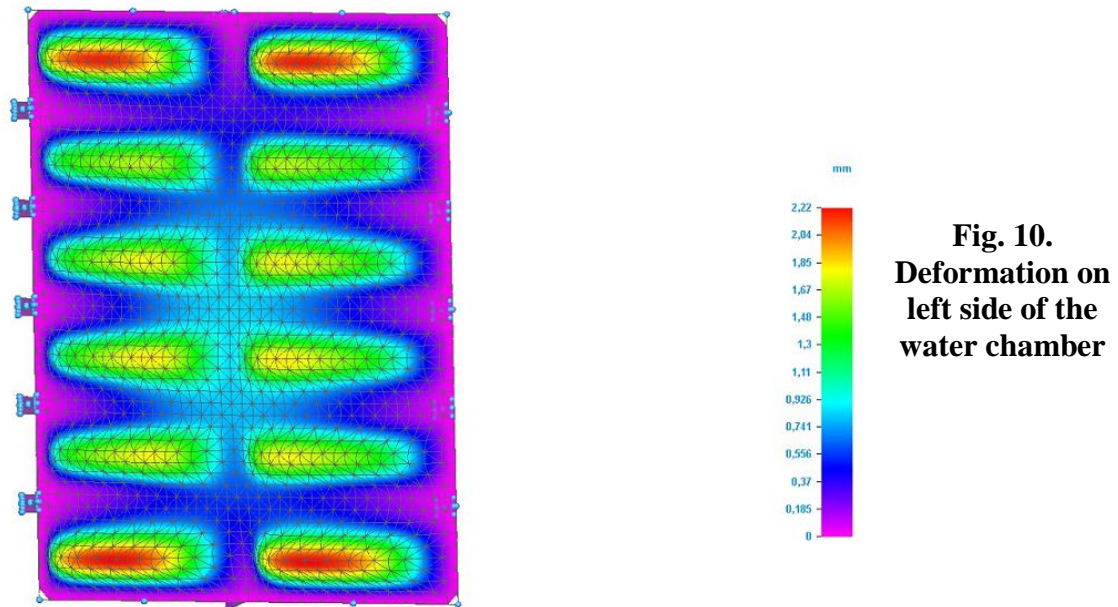

Fig. 9.
Stresses on the surface of left side of the water chamber



By the aid of the program the walls of the water chamber can be analyzed particularly. Effects of adjacent parts on each other were taken into consideration as rigidly fastened end cross-sections. On the basis of figures and data it is observable excepting the stress concentration effect of corners the stress peaks are under the yield point of the applied steel. It was a special question the application of long and short bracing beams.

4. SOME QUESTIONS OF BRACING OF THE BLADES

In case of application square shaped walls the length of bracing beams and their moment curves are the same. In Fig.11-12 the bracing beams can be seen. The ratio between their lengths is 1:2. In Fig. 13 the moment curves of the beams can be seen.

Two different constraint conditions were analyzed. There are quite big differences between the load of long and short beams in maximum value of moment. The pressure on blade surface: 1 bar.

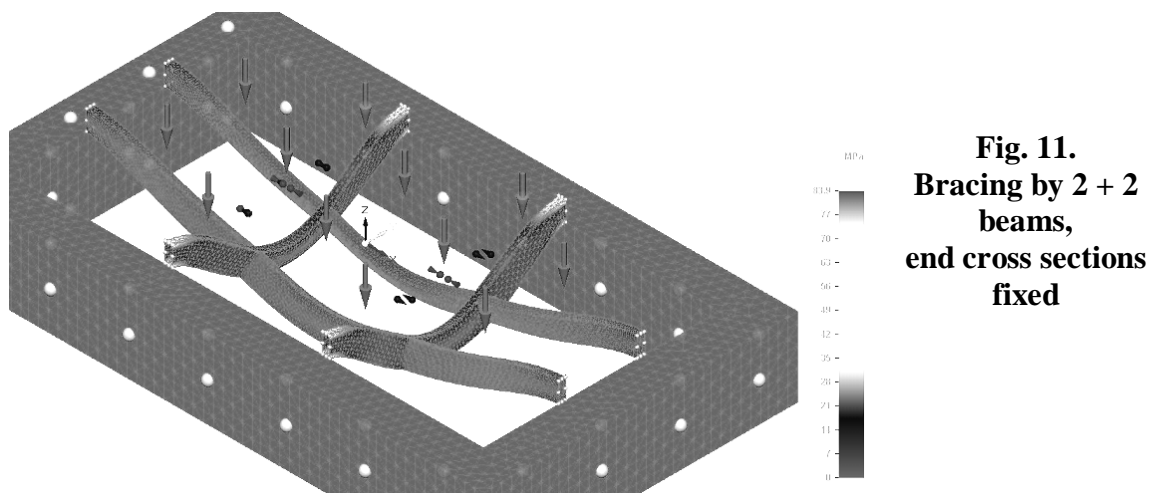

In the figures it can be seen that at a ratio 1:2 the load of long beams is much less than the load of short beams for this reason their role in the construction is unfounded. This is the explanation of missing of long beams in case of similar constructions.

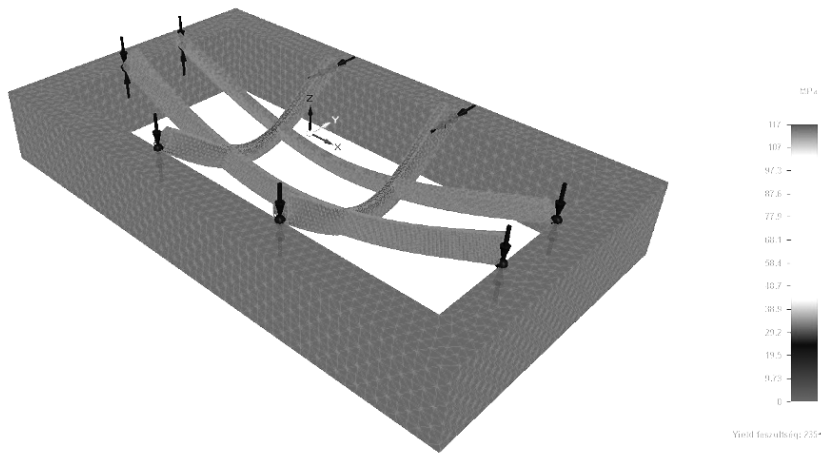

Fig. 12.
Bracing by 2 + 2
beams,
at their end
hinges

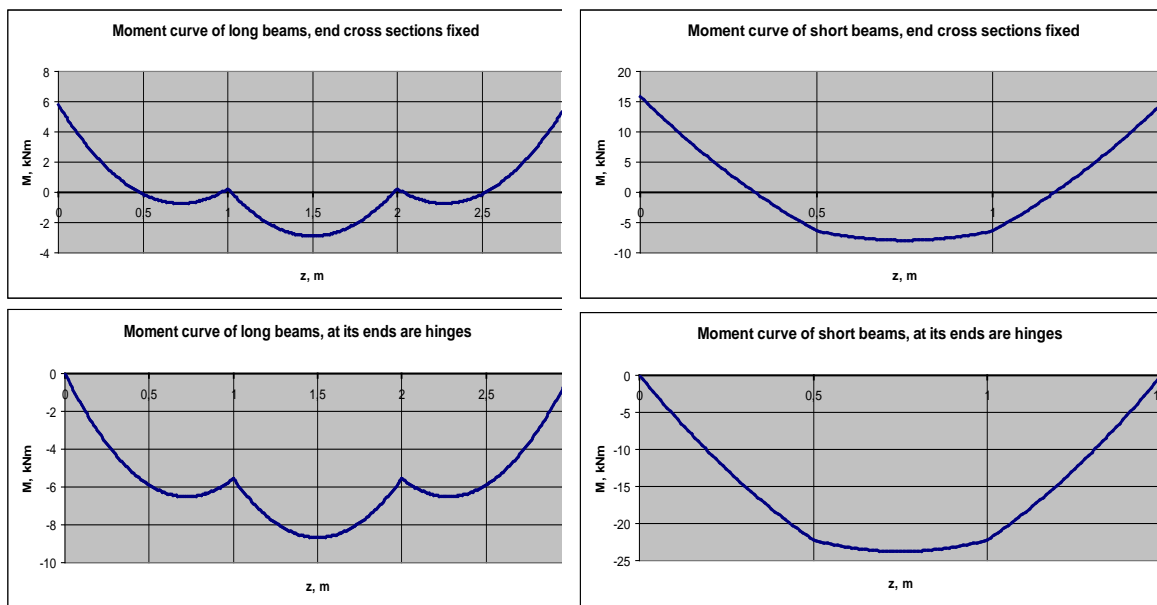

Fig. 13. Moment curves of bracing beams

5. CONCLUSION

Summing up it is clear that the water chamber of the boiler resists the load caused by test pressure. The pressure inside during operation is maximum 30-40 % of the test pressure. The material and thickness of applied blades moreover the material and cross section of bracing beams and positions are correct. Significant loss in weight cannot be reached without considerable modification of the actual construction.

REFERENCES

1. M. Csizmadia, B.; Nándori, E. (ed.): Mechanika mérnököknek, Szilárdságtan, Nemzeti Tankönyvkiadó, Budapest, 2003.
2. Béda, Gy.-Kozák, I.: Rugalmas testek mechanikája, Műszaki Könyvkiadó, Budapest, 1987.
3. Páczelt, I.-Szabó, T.-Baksa, A.: A végeelem-módszer alapjai, HEFOP jegyzet, 2007.