

# VERIFICATION OF BERNOULLI LAW USING THE SOFTWARE AUTODESK SIMULATION CFD

<sup>1</sup>V. Alexa, <sup>2</sup>I. Kiss, <sup>3</sup>S. Rațiu

<sup>1</sup>Politehnica University Timișoara, Faculty of Engineering Hunedoara, Revoluției 5, 331028, Hunedoara, Romania, e-mail: vasilalex@fh.upt.ro

<sup>2</sup>Politehnica University Timișoara, Faculty of Engineering Hunedoara, Revoluției 5, 331028, Hunedoara, Romania, e-mail: imre.kiss@fh.upt.ro

<sup>3</sup>Politehnica University Timișoara, Faculty of Engineering Hunedoara, Revoluției 5, 331028, Hunedoara, Romania, e-mail: sorin.ratiu@fh.upt.ro

## ABSTRACT

Using Fluid Dynamics Analysis (CFD) provides the opportunity to achieve a faster and more thorough study of fluid flow processes and is an important step to obtain information that cannot be obtained otherwise. The finite element method is generally more accurate than the finite volume method, but finite volume method can achieve more accurate mass balances using the balance sheet continuity per volume control. Finite volume method is more appropriate when fluid transport, while the finite element method is used more in the calculations of tension or conduction, which satisfies local continuity condition, is of less importance. Fluid Dynamics Analysis (CFD) is used in numerical analyzes, based on a set of mathematical expressions on linear complex equations defining fundamental fluid flow and heat transfer. This paper presents the simulation of air flow through a tube of special construction in interpreting the law of Bernoulli energy. Laboratory systems are shown, respectively simulating the actual fluid flow.

Keywords: Bernoulli, simulation, Autodesk, CFD

## 1. INTRODUCTION

Theoretical research CFD simulation method mainly aims to study the fluid flow in specific circumstances. CFD programs are recognized as an integral part of computing techniques CAE (Computer Aided Engineering) and is used in numerical analyzes, based on a set of mathematical expressions on linear complex equations defining fundamental fluid flow and heat transfer [1-6].

These equations are solved iteratively using complex algorithms incorporated into CFD programs. They allow carrying out research on the behavior of a fluid stream in a known geometric area [5, 6].

Methods of calculation and analysis of fluid dynamics, using specialized programs in the Computational Fluid Dynamics Analysis (CFD) simulation by enabling computers to fluid flow, heat transfer and associated phenomena, in which fluid flow phenomenon is predominant. Using CFD, provides the opportunity to achieve a faster and more thorough study of fluid flow processes and is an important step to obtain information that cannot be obtained otherwise [4-6].

Current commercial CFD codes, using three methods of spatial mesh structure are presented in Fig. 1.

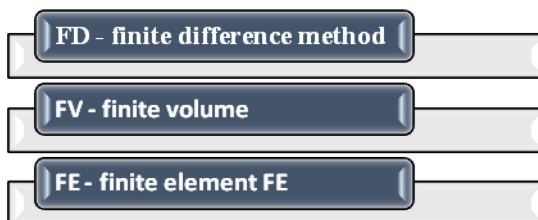

Figure 1. Three methods of spatial mesh structure for current commercial CFD codes

The finite element method is generally more accurate than the finite volume method, but finite volume method can achieve more accurate mass balances using the balance sheet continuity per volume control. Finite volume method is more appropriate when fluid transport, while the finite element method is used more in the calculations of tension or conduction, which satisfies local continuity condition, is of less importance.

The output of CFD programs can be viewed graphically by plotting velocity vectors color, contour pressure fields, fields with constant properties of the flow field, and are presented as numerical data and chart sin 2D or 3D system.

Autodesk Simulation CFD provides analysis functions fast, precise and direct innovative product development phase, where decision making is critical. CFD simulation extends Digital Prototyping concept for cooling equipment to the electronics, mechanical, industrial and consumer products [7, 8]. Typically, conducting any flow analysis involves several steps such as presented in Fig. 2.

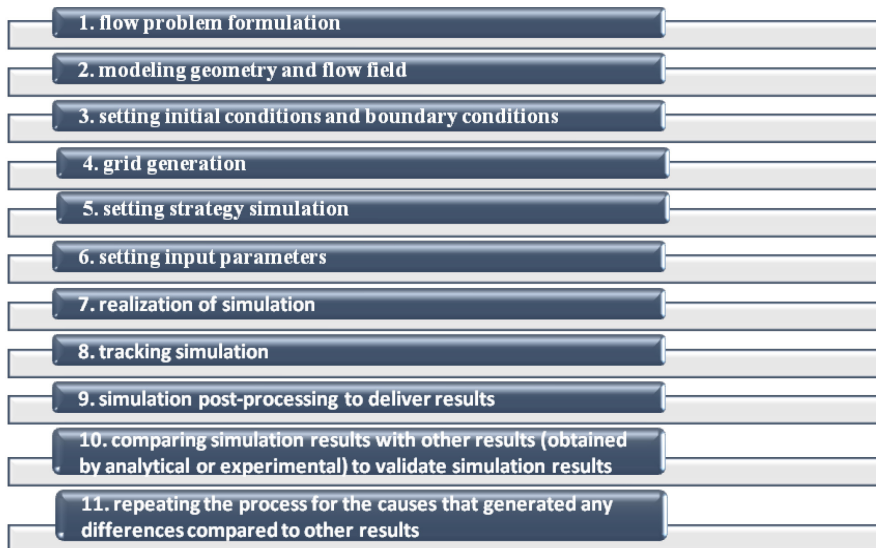

Figure 2. Several steps in conducting the flow analysis

**2. BERNOULLI’S LAW. EXPERIMENTAL TEACHING STAND**

Fluid dynamics studies the motion of fluids and their interaction with rigid bodies, taking into account the forces involved and energy transformations produced during movement [1-6]. In fluid dynamics apply general principles of general mechanics, laws of variation and conservation laws.

To establish the necessary conditions Bernoulli additional fluid motion:

- i. equation will determine the current line equations:

$$\frac{dx}{u} = \frac{dy}{v} = \frac{dz}{w} \tag{1}$$

- ii. mass force field is a potential field, so:

$$X = \frac{\partial U}{\partial x}, \quad Y = \frac{\partial U}{\partial y}, \quad Z = \frac{\partial U}{\partial z} \tag{2}$$

the movement of the fluid the movement to be permanent, ie hydrodynamic parameters are not dependent on the time point, hence:

$$\frac{\partial u}{\partial t} = \frac{\partial v}{\partial t} = \frac{\partial w}{\partial t} = \mathbf{0} \tag{3}$$

- iii. fluid the movement to be potential, ie velocity components can be expressed in terms of a potential

$$u = \frac{\partial \varphi}{\partial x}, \quad v = \frac{\partial \varphi}{\partial y}, \quad w = \frac{\partial \varphi}{\partial z}, \text{ from which it follows that } \omega_x = \omega_y = \omega_z = \mathbf{0} .$$

If you express the equation of motion given by Gromek-Lamb we introduce whirl vector components, we obtain the relations [1]:

$$\begin{cases} \frac{\partial u}{\partial t} + \frac{\partial}{\partial x} \left( \frac{V^2}{2} + \int \frac{dp}{\rho} + U \right) + 2(w\omega_y - v\omega_z) = 0 \\ \frac{\partial v}{\partial t} + \frac{\partial}{\partial x} \left( \frac{V^2}{2} + \int \frac{dp}{\rho} + U \right) + 2(u\omega_z - w\omega_x) = 0 \\ \frac{\partial w}{\partial t} + \frac{\partial}{\partial x} \left( \frac{V^2}{2} + \int \frac{dp}{\rho} + U \right) + 2(v\omega_x - u\omega_y) = 0 \end{cases} \quad (4)$$

Multiplying these equations by dx, dy, dz and adding, we get:

$$\frac{\partial}{\partial t} (udx + vdy + wdz) + d \left( \frac{V^2}{2} + \int \frac{dp}{\rho} + U \right) + 2 \begin{vmatrix} dx & dy & dz \\ \omega_x & \omega_y & \omega_z \\ u & v & w \end{vmatrix} = 0 \quad (5)$$

If additional conditions imposed, the equation obtained is:

$$d \left( \frac{V^2}{2} + \int \frac{dp}{\rho} + U \right) = 0 \quad (6)$$

If we integrate this equation between two points within the current line or between any two points are in a moving current potential is obtained:

$$\frac{V^2}{2} + \int \frac{dp}{\rho} + U = C \quad (7)$$

where C is a constant value throughout the mass fluid.

The constant motion of fluids incompressible ( $\rho = \text{const.}$ ) In the gravitational field ( $U = gz+ct.$ ) the relationship becomes:

$$\frac{V_1^2}{2} + \frac{p_1}{\rho} + gz_1 = \frac{V_2^2}{2} + \frac{p_2}{\rho} + gz_2 \text{ sau } \frac{V_1^2}{2g} + \frac{p_1}{\gamma} + z_1 = \frac{V_2^2}{2g} + \frac{p_2}{\gamma} + z_2 \quad (8)$$

If permanent movement virtually incompressible fluid taking place in a field of forces negligible mass ( $(fm \cong 0)$ , so  $U = \text{const.}$ ), the relationship is written:

$$\frac{V_1^2}{2} + \frac{p_1}{\rho} = \frac{V_2^2}{2} + \frac{p_2}{\rho} \quad (9)$$

Equation (9) is lighter fluid Bernoulli relationship (in case they can be considered to be practically incompressible) and the pressure at relatively low speed (for example, drawing in air to a carburetor, the air ducts), or to the liquid if the forces of gravity can be neglected compared to the forces of inertia and pressure forces (ie movement through the drive pressure showing no differences quota practically horizontal movement of water through small diameter pipes). In some cases the relationship can be written as:

$$p_1 + \rho \frac{V_1^2}{2} = p_2 + \rho \frac{V_2^2}{2} \quad (10)$$

where p is the piezometric pressure (also called static pressure),  $\rho V^2/2$  is the dynamic pressure and the sum of  $p + \rho V^2/2$  is the total pressure.

By doing dimensional analysis of the terms in equation (8), we see that each has dimensions of length, which allows a graphical representation of the entire expression.

Consider a horizontal reference plane OO chosen arbitrarily and DC current line, some, we choose three points  $M_1, M_2, M_3$  which to plan coordinates  $z_1, z_2, z_3,$  and particles passing through these points are hydrodynamic parameters  $(v_1, p_1), (v_2, p_2), (v_3, p_3),$  Fig. 3.

Equality shows that the sum of the three segments  $z, p/\gamma, v^2/2g$  must be the same for all points. The locus of points at the end segments  $(z + p/\gamma)$  PP line, called the piezometric line and the line EE, the design is horizontal and parallel to the OO so called energy lines or energy level. Apply Bernoulli's relationship to the three points in the current line:

$$\frac{V_1^2}{2g} + \frac{p_1}{\gamma} + z_1 = \frac{V_2^2}{2g} + \frac{p_2}{\gamma} + z_2 = \frac{V_3^2}{2g} + \frac{p_3}{\gamma} + z_3 = Ct. \tag{10}$$

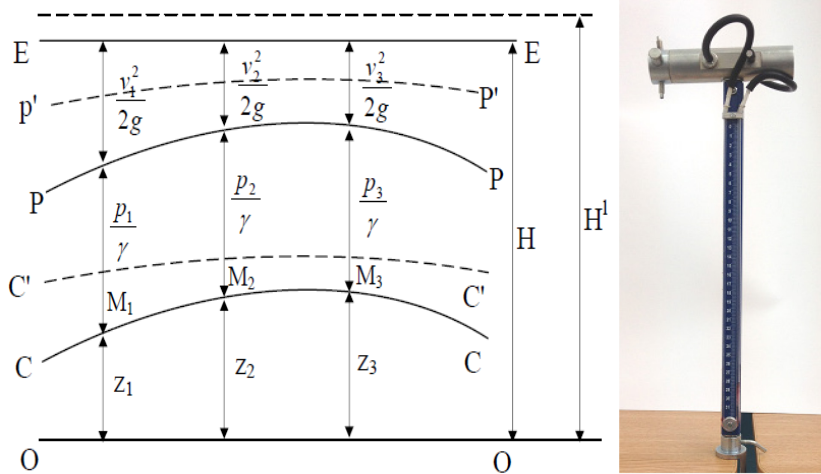

Figure 3. The energy lines and the measurement apparatus

Distance constant value of H plotted Bernoulli relationship varies from a current line to another. Another way to streamline denoted C'-C 'piezometric line is P'-P' and the constant has the value H'. For the interpretation of the relationship Bernoulli energy, multiply particle weight  $m \cdot g$  relationship, as follows:

$$\frac{mV^2}{2} + pV + mgz = ct. \tag{11}$$

The first term is the kinetic energy of particle, the second term represents the potential energy of pressure and the third is the potential energy of position.

It can be concluded that the fluid moving permanent forces arising from the mass potential, the amount of kinetic energy, potential energy, and the pressure potential energy of position remain constant for all the points located on the same power line.

The verification Bernoulli's law is an apparatus for the teaching of fluid mechanics. Outside verify Bernoulli's law, the device allows experimental phenomena and laws. This unit can be used as Prandtl Pitot tube or tube. It is designed to be used, preferably together with an ordinary vacuum cleaner. Experiences that can be achieved with this device, and relative errors, passed in parenthesis are:

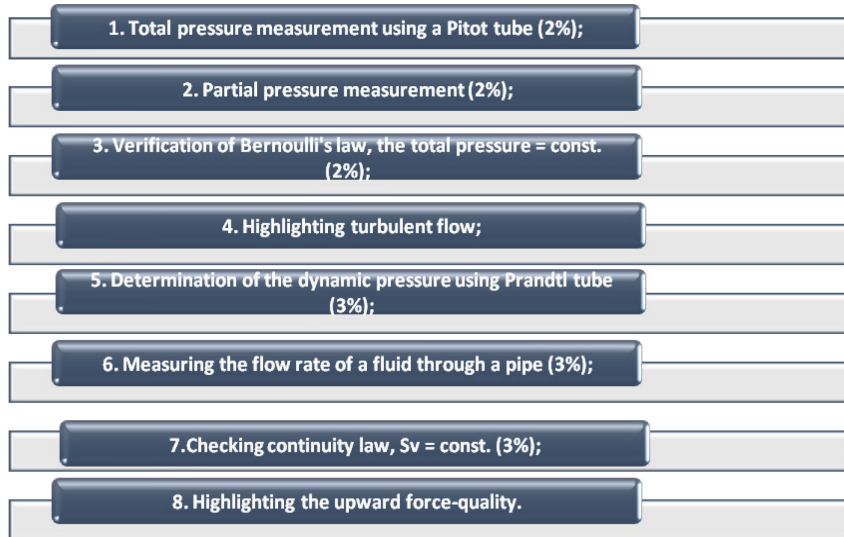

Figure 4. Achieved experiences and the errors

### 3. COMPUTERISED SIMULATION OFFLUID FLOWTHROUGH THE DEVICEPROPOSED

Replacing experimental research on real systems with theoretical modeling, virtual systems allowed a significant reduction of time and costs associated with development, design and manufacture of new types of installations. The steps of the simulation by CFD are described, in the followings.

#### 3.1. Pre-processing

Configuring a problem solving model with CFD programs has three distinct steps:

- create or import 3D geometric model;
- creation of the mesh;
- physical configuration of the problem.

In geometric modeling, topology simulation model is established in the initial phase of designing geometric pattern with CAD programs [7-12]. At this stage the interaction interfaces are set solid and fluid main regions. For designing 3D geometric model of the device was used CATIA software [7, 8, 10].

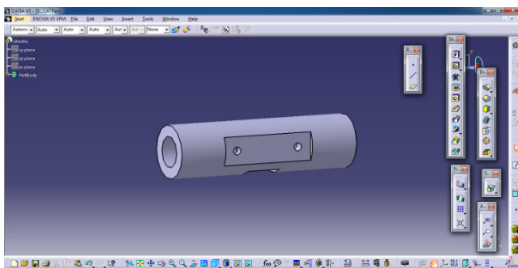

Figure 5. 3D device design using software CATIA V5

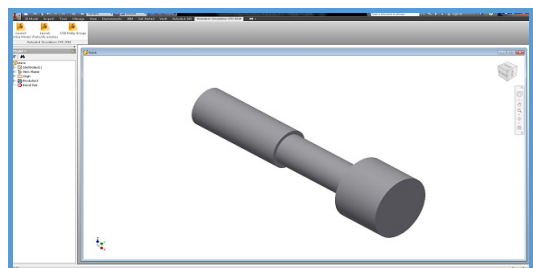

Figure 6. The interior of the device designed

Steps to create the network are:

- i. delimiting regions geometric model (Fig. 6), in which case the tube design is presented;
- ii. the choice of the working fluid which passes through tube design (Fig. 7) and the mesh area of the interior volume thereof (Fig. 8) by generating area network, and generating network volume. Spatial discretization of the domain must obtain seamless the network of spaces without introducing elements or cells with large deformations.

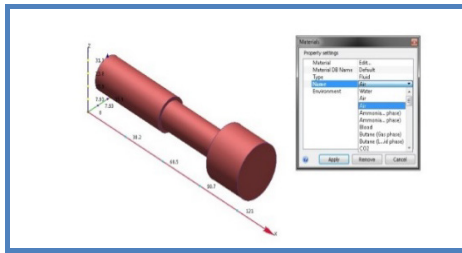

Figure 7. The choice of fluid

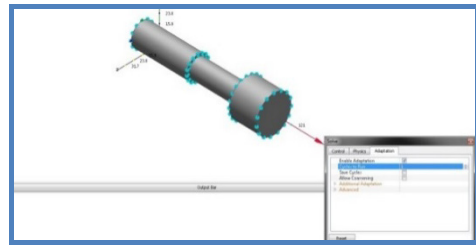

Figure 8. To mesh the volume

iii. setting boundary conditions by setting the direction off low of input and output parameters (Fig. 9).

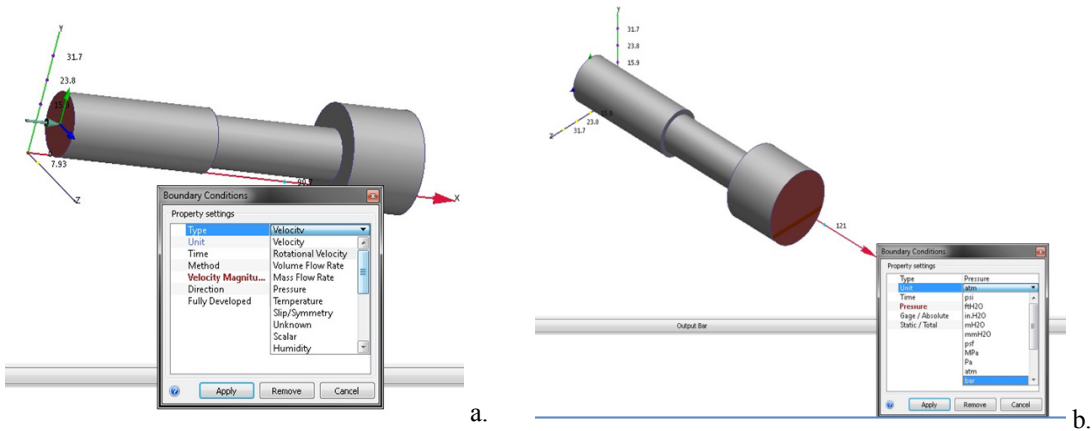

Figure 9. Setting boundary conditions. a) entry into the tube; b) the outlet tube

### 3.2. Solving CFD

The boundary conditions defined, the simulation can be performed. The last step in obtaining the desired data post-processing of data in the data sets necessary analyzes are taken from the simulation data. To solve differential equations with partial derivatives, fundamental to conservation of angular momentum and scalar quantities (mass, energy or turbulence) CFD codes using an unobtrusive integration based on service volume control (Fig. 10).

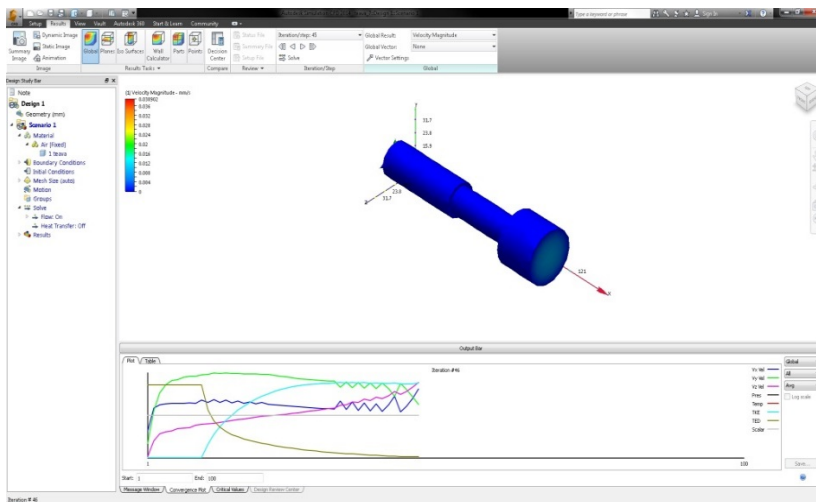

Figure 10. Integrating discrete based on technique of control volume

The calculation method has the advantage of reduced computational resource consumption and better approximates the entire volume control value, which is given by the central node, but the second method calculates the integrated value of the particular area where it is midway between the two nodes.

Finite volume method involves two levels of approximation values:

- calculating surface volume control variables-interpolation;
- calculating the volume and surface integrals-integration.

### 3.3. Post-processing

When numerical simulation reaches convergence, the final data set is stored as a final solution. This data set is the registration status of all elements in the model, speed, density, pressure, flow aspects, etc. In order to be interpreted the data, they must be ordered and reduced size understandable.

This data display is called post processing and simulation makes it possible to compare current data with data from other simulations or external data, e.g. from experimental research (Fig. 11, Fig. 12).

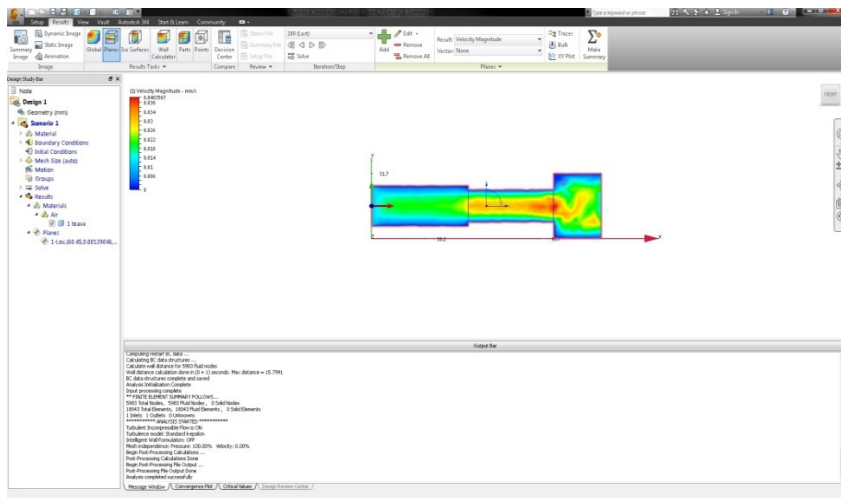

Figure 11. The velocity field

There are many ways to display the data, so it is important to make a selection of data representation to compare them with other data sets.

The standard viewing options available are the contour plots of the velocity vector.

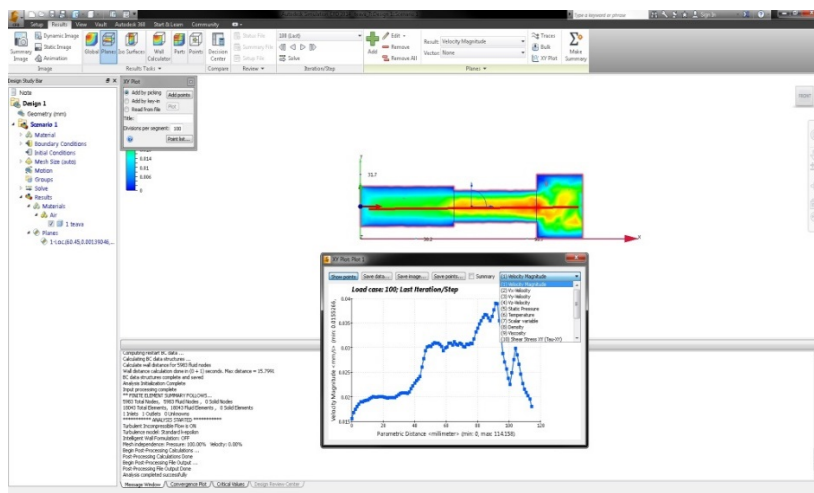

Figure 12. Distribution speed in mm/sec along the length of the device designed

#### 4. CONCLUSIONS

This paper presented a stand that allow teachers:

- ✓ total pressure measurement using a Pitot tube;
- ✓ measurement of the partial pressure;
- ✓ verification of Bernoulli's law, the total pressure= ct.;
- ✓ highlighting the turbulent flow; determining dynamic pressure using Prandtl tube;
- ✓ measuring the flow rate of a fluid through a pipe (3%);
- ✓ check continuity law,  $Sv=ct.$ (3%); the upward force-quality evidence.

With Autodesk CFD software were presented are the steps to simulate the flow inside the tube current, checking Bernoulli's law. The equations are solved iteratively using complex algorithms incorporated into CFD programs. They allow carrying out research on the behavior of a fluid stream in a known geometric area.

#### REFERENCES

- [1] Vasiliu, N. & co., Mecanica fluidelor și sisteme hidraulice, Editura Tehnică, București, 1999
- [2] Anderson, J.D. Fundamentals of Aerodynamics, New York, McGraw-Hill, 2001
- [3] Bar-Meir, G., Basics of Fluid Mechanics, 2013, [www.potto.org/downloads.php](http://www.potto.org/downloads.php)
- [4] Fitzpatrick, R., Fluid Mechanics lecture notes, 2012, FreeBookCentre.net
- [5] McDonough, J.M., Basic Computational Numerical Analysis, 2001, FreeBookCentre.net
- [6] McDonough, J.M., Lectures in computational fluid dynamics of incompressible flow: Mathematics, Algorithms and Implementations, 2007, FreeBookCentre.net
- [7] Cioată, V., Proiectare asistată de calculator cu Catia V5, Editura Mirton, Timișoara, 2009
- [8] Cioată, V., Miklos, I. Zs., Proiectare asistată de calculator cu Autodesk Inventor, Editura Mirton, Timișoara, 2009
- [9] [www.grc.nasa.gov/www/wind/valid/tutorial/process.html](http://www.grc.nasa.gov/www/wind/valid/tutorial/process.html).
- [10] [www.catia.com](http://www.catia.com)
- [11] [www.andrew.cmu.edu/course/24-688/handouts/](http://www.andrew.cmu.edu/course/24-688/handouts/)
- [12] [www.autodesk.com/education/student-software](http://www.autodesk.com/education/student-software)